

Note: Values Enclosed With  
[Brackets] Are In mm

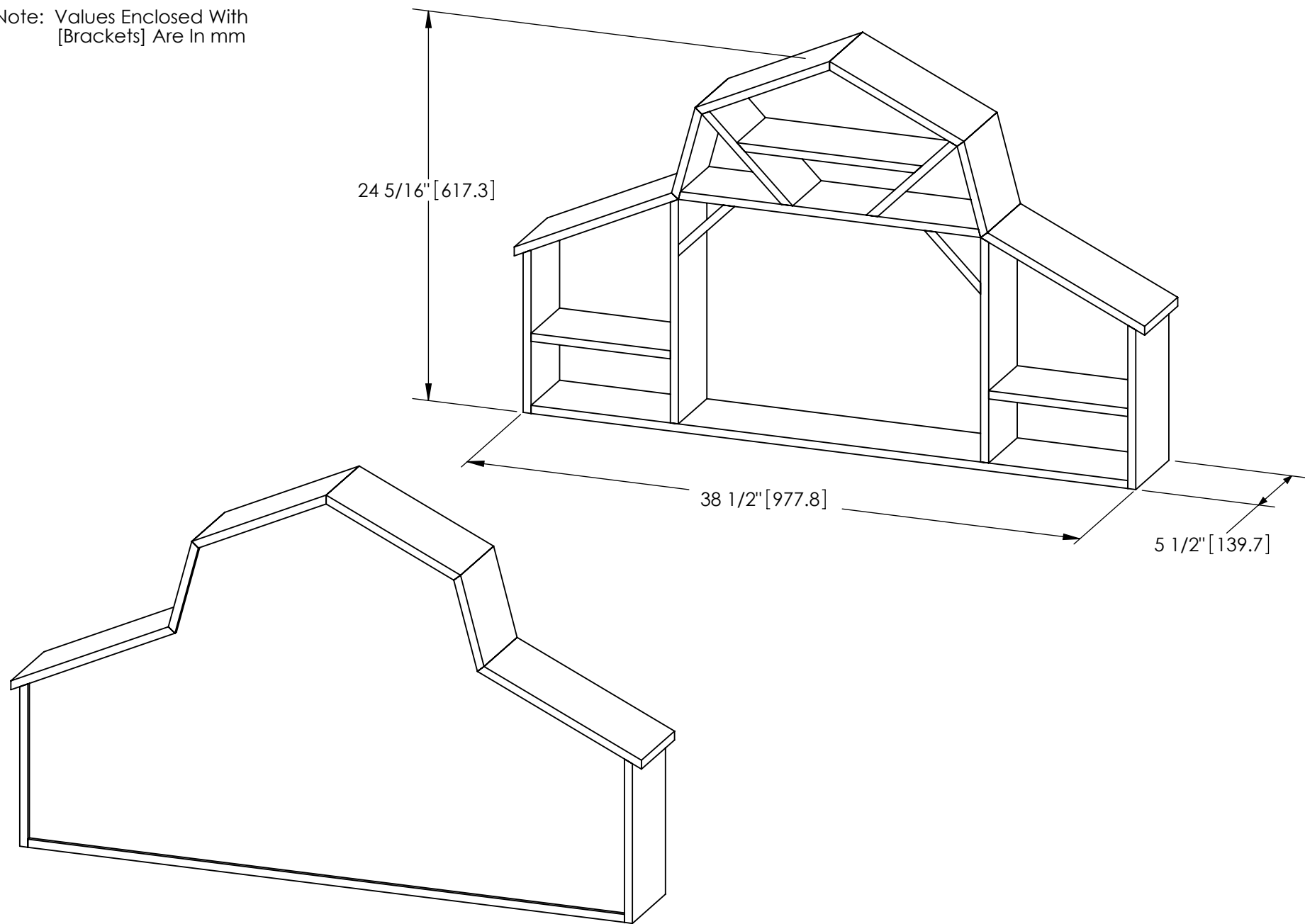

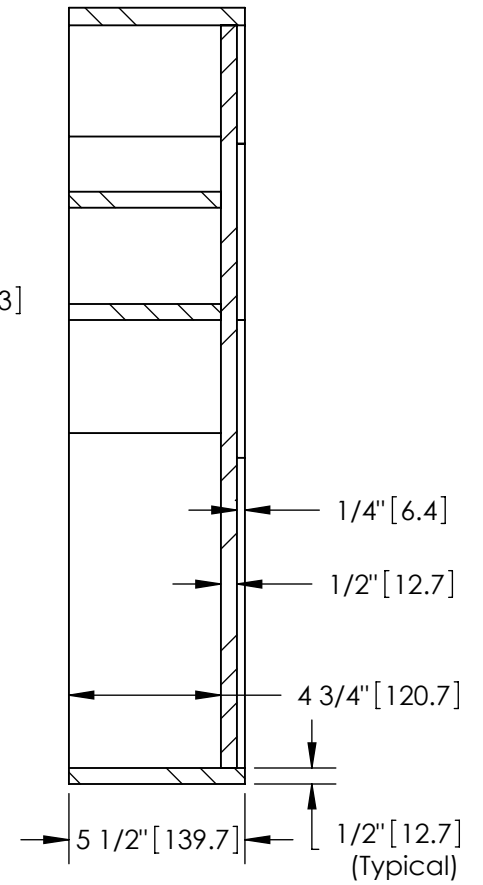

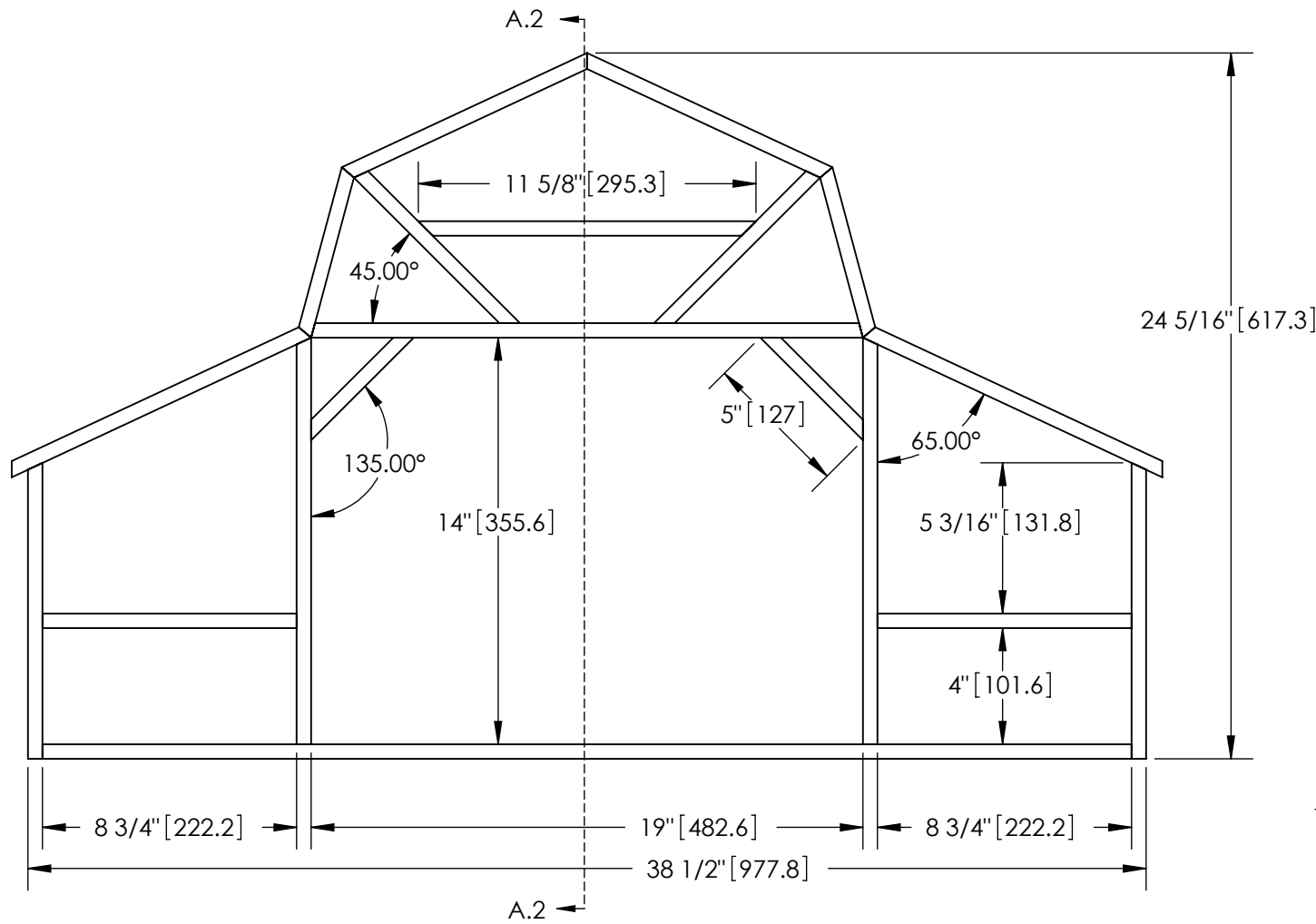

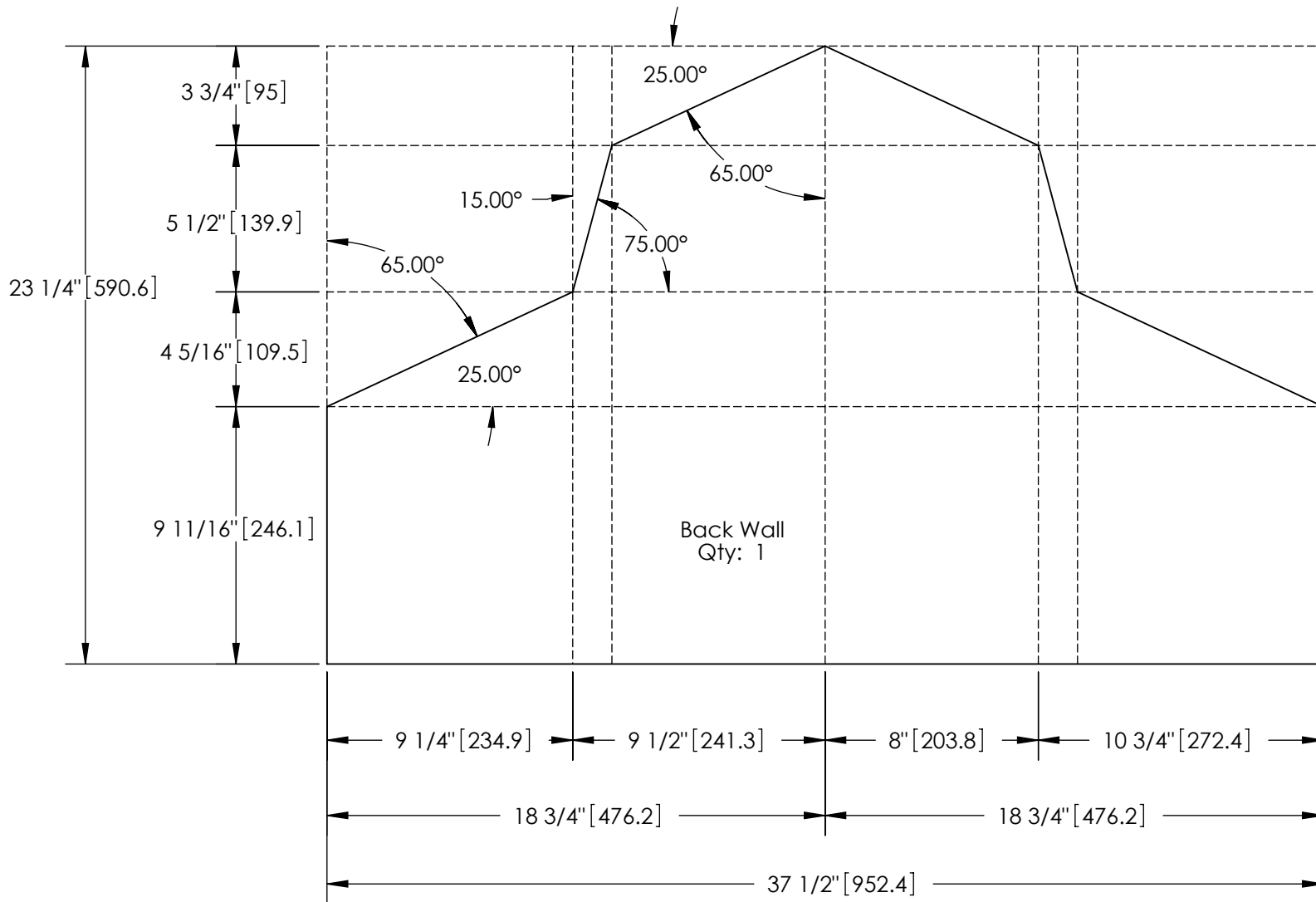
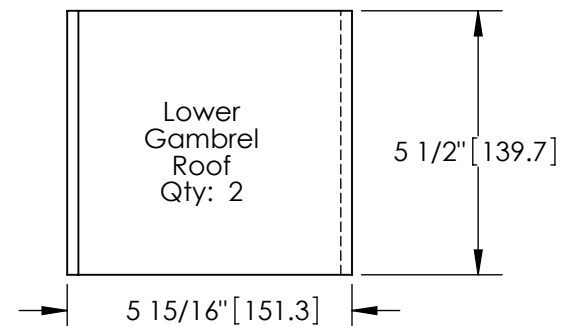
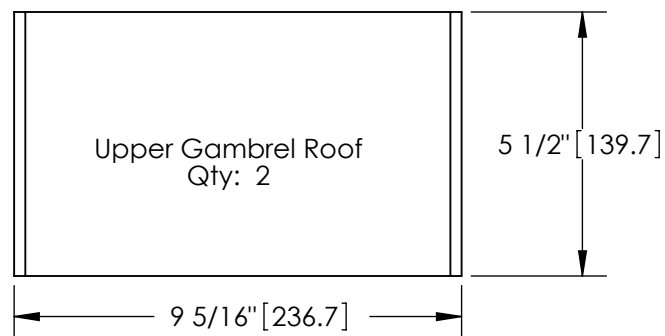
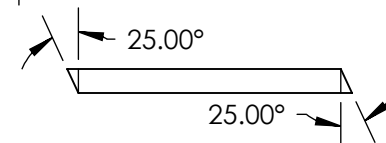
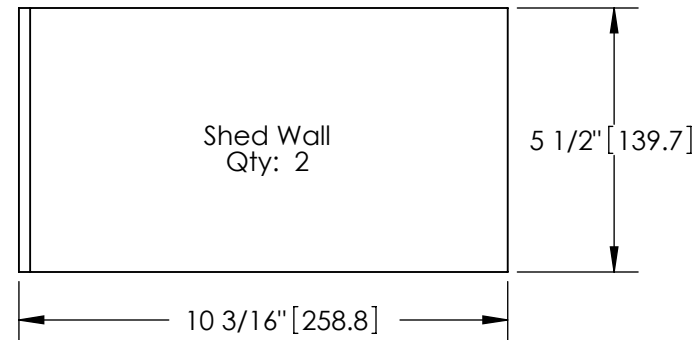
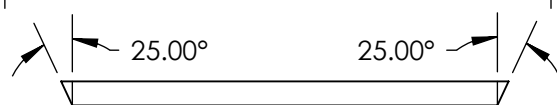
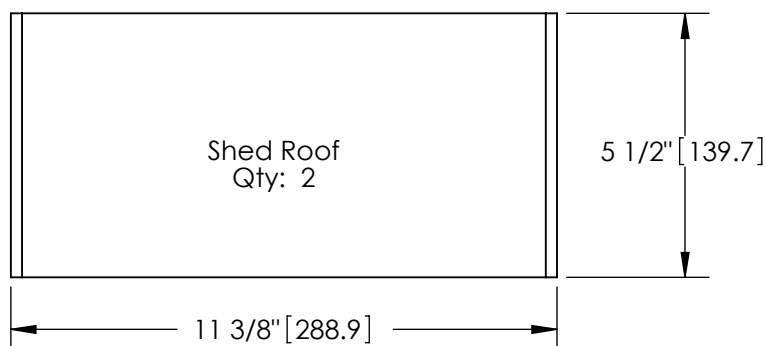
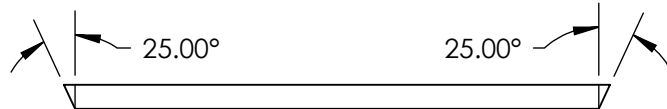
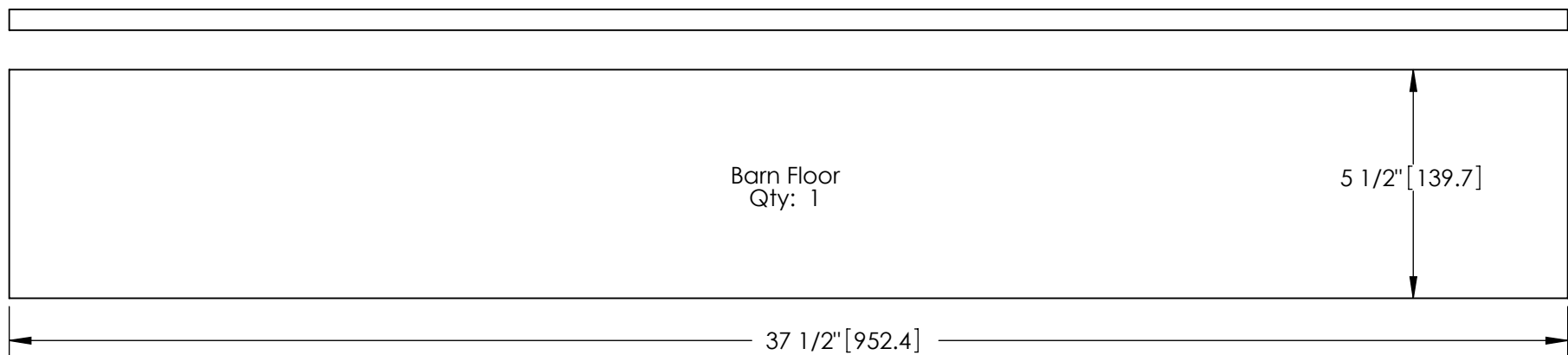

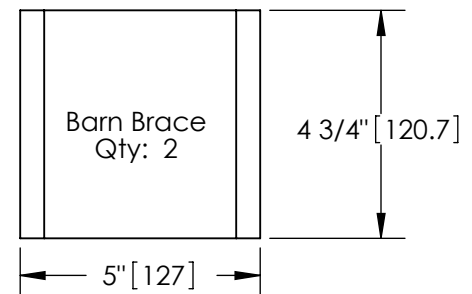
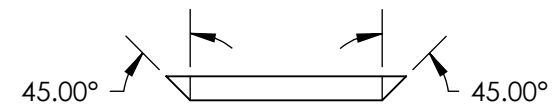
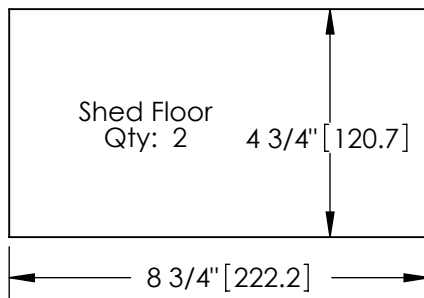
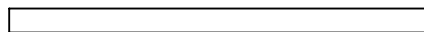
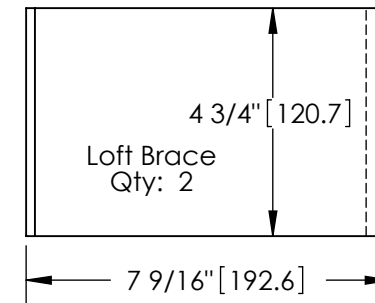
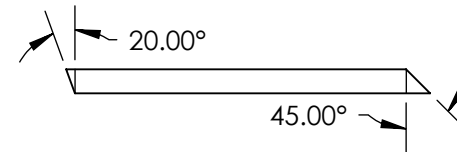
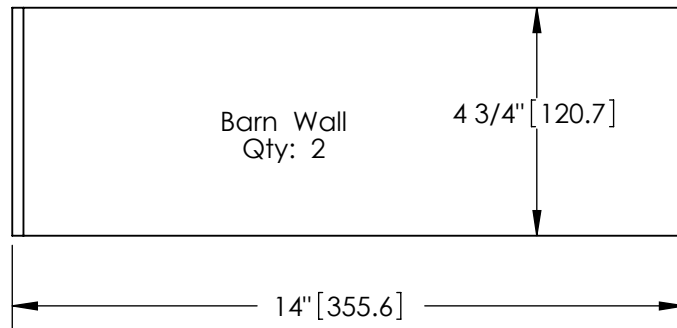
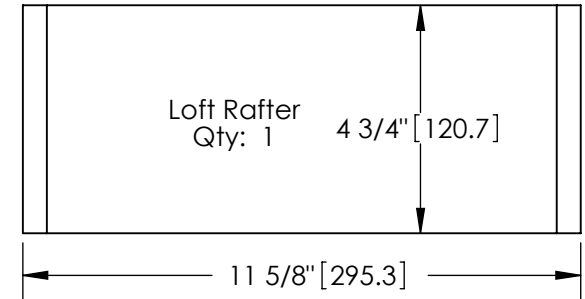
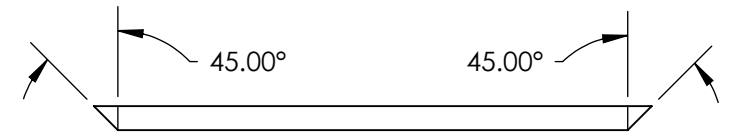
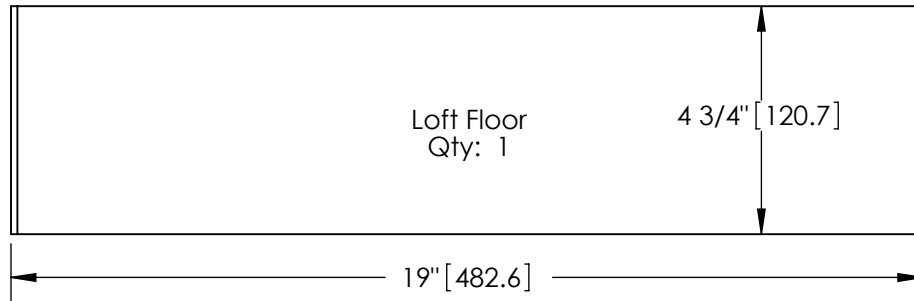
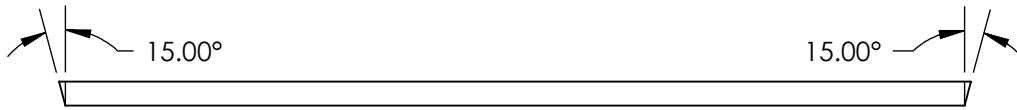

Parts List						
Item	Quantity	Description	Material	Thickness	Width	Length
1	1	Back Wall	MDF	1/2"	38"	23 3/4"
2	1	Barn Floor	MDF	1/2"	5 1/2"	38"
3	2	Shed Roof	MDF	1/2"	5 1/2"	11 7/8"
4	2	Shed Wall	MDF	1/2"	5 1/2"	10 11/16"
5	2	Upper Gambrel Roof	MDF	1/2"	5 1/2"	9 7/8"
6	2	Lower Gambrel Roof	MDF	1/2"	5 1/2"	6 1/2"
7	1	Loft Floor	MDF	1/2"	4 3/4"	19 1/2"
8	2	Barn Wall	MDF	1/2"	4 3/4"	14 1/2"
9	1	Loft Rafter	MDF	1/2"	4 3/4"	12 1/8"
10	2	Shed Floor	MDF	1/2"	4 3/4"	9 1/4"
11	2	Loft Brace	MDF	1/2"	4 3/4"	8 1/4"
12	2	Barn Brace	MDF	1/2"	4 3/4"	5 1/2"

